

E900型 Hand Hole

(600φ鉄蓋付)

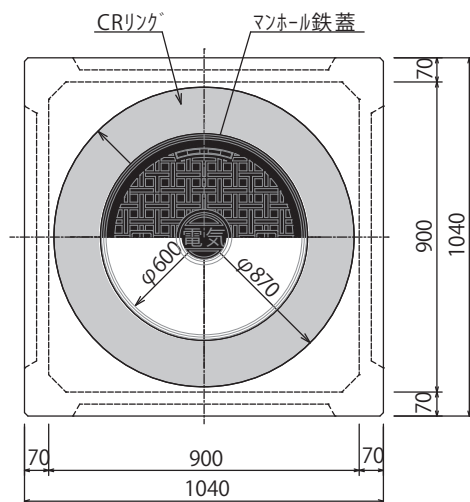

部材名称	参考重量(kg)
CRリング	※84
本体上部B2(小)	240
本体上部B2(大)	457
本体下部B1	525
中継部(H200)	131
中継部(H=400)	233

※鉄蓋丸枠の重量は含まず。

国土交通省規格H2-9

共通仕様: 住宅・都市整備公団型
EC-123-[I型]

国土交通省規格H2-6

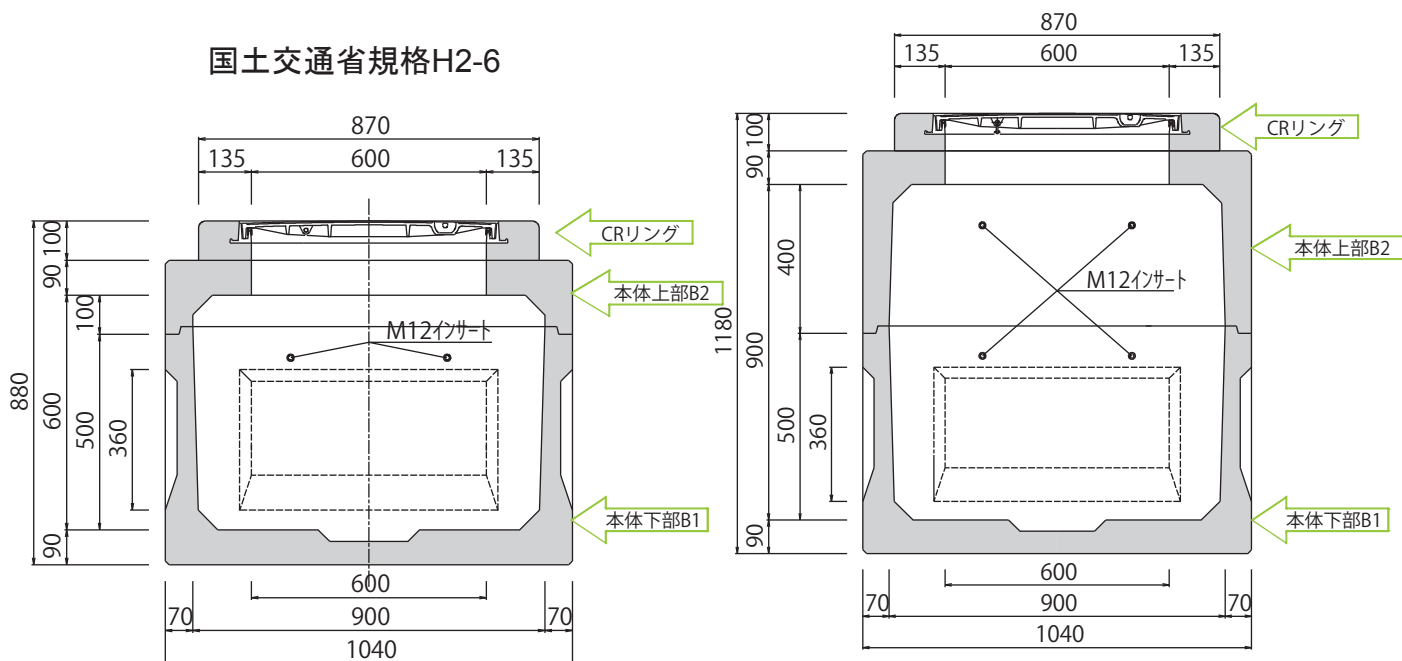

























品番	内径寸法	外径寸法	上部 (小・大)	中継高さ数量 (mm)	参考重量 (kg)
E-0906	900×900× 600	1040×1040× 880	小	—	849
E-0908	900×900× 800	1040×1040×1080	小	200	980
E-0909	900×900× 900	1040×1040×1180	大	—	1066
E-0910	900×900×1000	1040×1040×1280	小	400	1082
E-0911	900×900×1100	1040×1040×1380	大	200	1197
E-0912	900×900×1200	1040×1040×1480	小	200+400	1213
E-0913	900×900×1300	1040×1040×1580	大	400	1299
E-0914	900×900×1400	1040×1040×1680	小	400×2	1315
E-0915	900×900×1500	1040×1040×1780	大	200+400	1430

図面ダウンロード

PDF・DXF・JWW形式の図面をご用意しております。

以下の一覧よりご入用の図面アイコンをクリックしてダウンロードしてください。

品番	PDF	DXF	JWW
E-0906			
E-0908			
E-0909			
E-0910			
E-0911			
E-0912			
E-0913			
E-0914			
E-0915	