

# E1500型 Hand Hole

(600φ鉄蓋付)

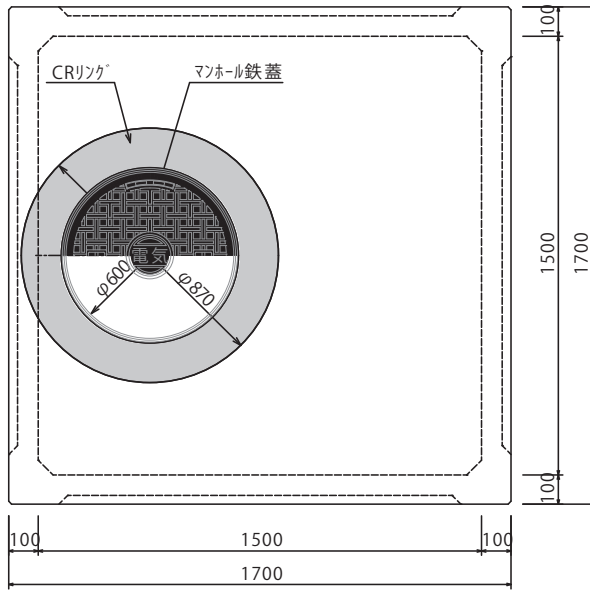

| 部材名称      | 参考重量(kg) |
|-----------|----------|
| CRリング     | ※84      |
| 本体上部B2(小) | 956      |
| 本体上部B2(大) | 2111     |
| 本体下部B1    | 1916     |
| 中継部(H300) | 459      |

※鉄蓋丸枠の重量は含まず。

本体上部B2(小)

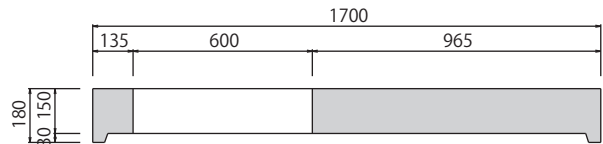

本体中継部材

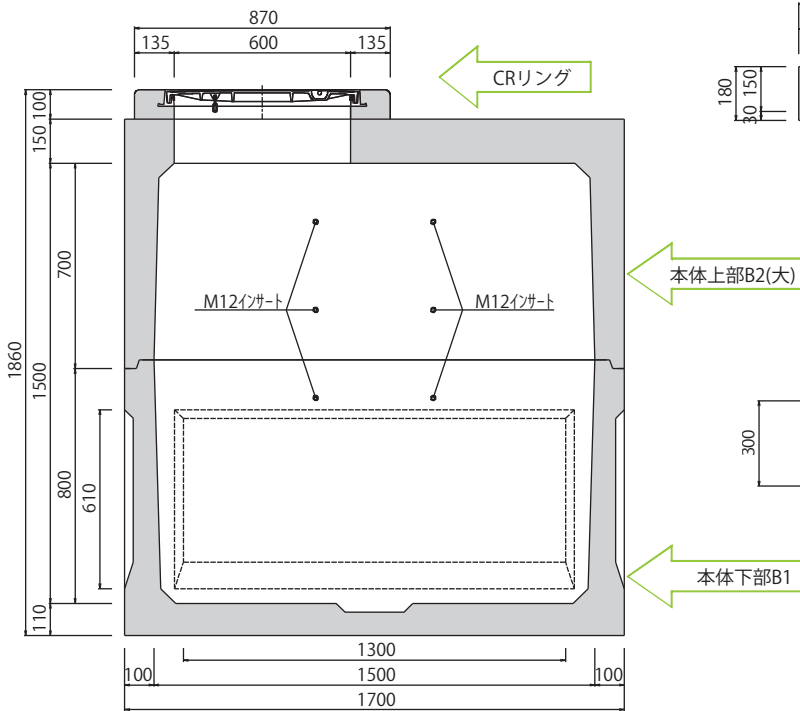
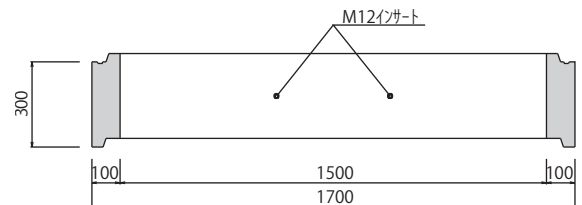



























| 品番     | 内径寸法           | 外径寸法           | 上部<br>(小・大) | 中継高さ数量<br>(mm) | 参考重量<br>(kg) |
|--------|----------------|----------------|-------------|----------------|--------------|
| E-1508 | 1500×1500× 830 | 1700×1700×1190 | 小           | —              | 2956         |
| E-1511 | 1500×1500×1130 | 1700×1700×1490 | 小           | 300            | 3415         |
| E-1512 | 1500×500 ×1230 | 1700×1700×1590 | 小           | 400            | 3568         |
| E-1514 | 1500×1500×1430 | 1700×1700×1790 | 小           | 300×2          | 3874         |
| E-1515 | 1500×1500×1500 | 1700×1700×1860 | 大           | —              | 4111         |
| E-1517 | 1500×1500×1730 | 1700×1700×2090 | 小           | 300×3          | 4570         |
| E-1518 | 1500×1500×1800 | 1700×1700×2160 | 大           | 300            | 4570         |
| E-1520 | 1500×1500×2030 | 1700×1700×2390 | 小           | 300×4          | 4792         |
| E-1521 | 1500×1500×2100 | 1700×1700×2450 | 大           | 300×2          | 4765         |

## 図面ダウンロード

PDF・DXF・JWW形式の図面をご用意しております。

以下の一覧よりご入用の図面アイコンをクリックしてダウンロードしてください。

| 品番     | PDF  | DXF  | JWW  |
|--------|--|--|--|
| E-1508 |   |   |   |
| E-1511 |   |   |   |
| E-1512 |   |   |   |
| E-1514 |   |   |   |
| E-1515 |   |   |   |
| E-1517 |   |   |   |
| E-1518 |   |   |   |
| E-1520 |   |   |   |
| E-1521 |  |  |  |