

E1200型 Hand Hole

(600φ鉄蓋付)

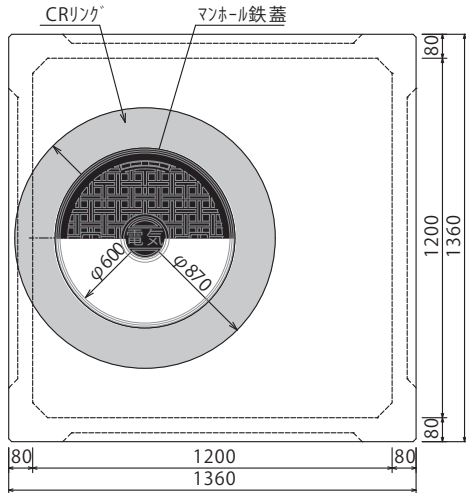

部材名称	参考重量(kg)
CRリング	※84
本体上部B2(小)	462
本体上部B2(大)	1081
本体下部B1(小)	969
本体下部B1(大)	1110
中継部(H300)	288

※鉄蓋丸枠の重量は含まず。

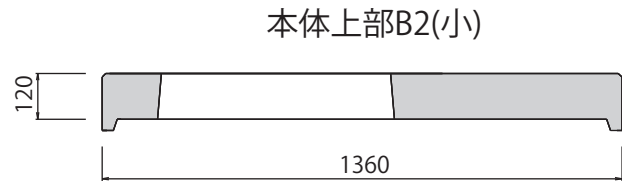
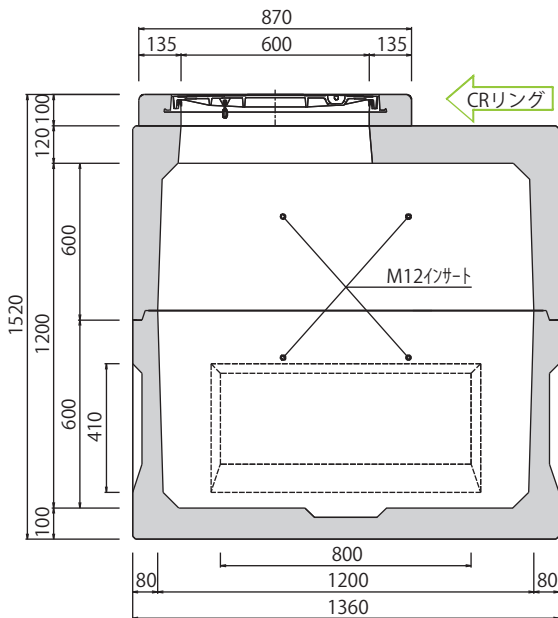

← 本体上部B2(大)

本体中継部材

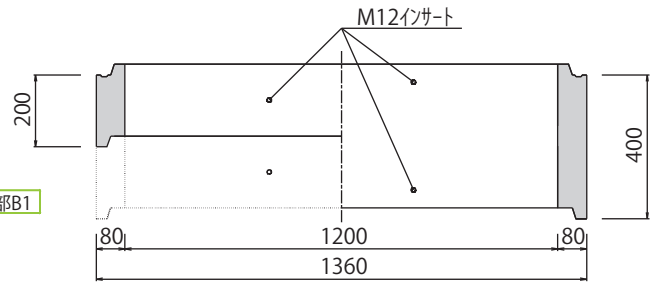

← 本体下部B1













※E-1200型ハンドホールは、下部B1が2種類(H600,H700)あり、更に中継(H200、H400ノックアウト付)上部B2(H0、H500)とも各2種類揃えており、組合せのバリエーションが豊富です。

品番	内径寸法	外径寸法	上部 (小・大)	中継高さ数量 (mm)	参考重量 (kg)
E-1206	1200×1200× 630	1360×1360× 950	小	—	1515
E-1209	1200×1200× 930	1360×1360× 1250	小	300	1803
E-1212	1200×1200× 1200	1360×1360× 1520	大	—	2134
E-1215	1200×1200× 1530	1360×1360× 1850	小	300	2422
E-1218	1200×1200× 1800	1360×1360× 1820	大	300×	2710

図面ダウンロード

PDF・DXF・JWW形式の図面をご用意しております。

以下の一覧よりご入用の図面アイコンをクリックしてダウンロードしてください。

品番	PDF	DXF	JWW
E-1206			
E-1209			
E-1212			
E-1215			
E-1218	